



# Model HD 2701

Part No. 1.194-200.0

# Model HD 3101

Part No. 1.187-117.0

## High Pressure Washer Operator Manual

- Overview .....1
- Precautions .....1-2
- Assembly Instructions .....3
- Operating Instructions .....4
- Using the Accessories .....5
- Working with Detergents .....6
- Shut Down and Clean-Up .....7
- Taking a Break .....7
- Winterizing and Long-Term Storage .....7
- Cleaning Tips .....8-9
- Optional Cleaning Accessories .....9
- Troubleshooting .....10-11

**In USA Call:**  
**1-800-537-4129**  
 or visit our website:  
[www.karcher-usa.com](http://www.karcher-usa.com)

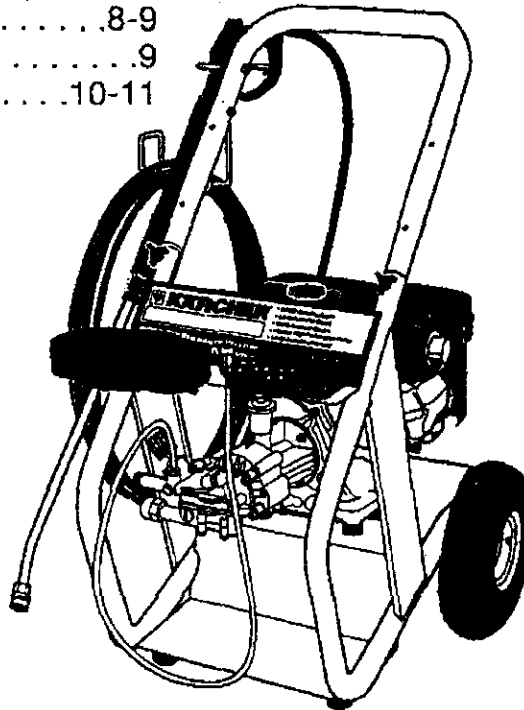

### Specifications Model HD 2701

Engine	7 HP Robin/Subaru
Max. operating pressure	2700 PSI
Max. water volume	2.8 GPM
Maximum water inlet temperature	104° Fahrenheit

### Model HD 3101

Engine	9 HP Robin/Subaru
Max. operating pressure	3100 PSI
Max. water volume	3.1 GPM
Maximum water inlet temperature	104° Fahrenheit

## Model HD 2701/3101 OVERVIEW

### Item Description

1. High pressure outlet
2. Water inlet with garden hose connector and filter
3. Detergent suction tube
4. Knob assembly (two each, Bolt & Knob)
5. High pressure hose
6. Hose storage handle
7. Detergent filter
8. Handle
9. Trigger gun
10. Trigger gun safety lock
11. Pull start (not pictured)
12. Gas tank
13. Oil fill cap
14. Spray wand with quick connect adapter
15. Quick connect nozzles (5)
16. Pressure control
17. Gun/hose storage handle
18. Detergen tray
19. Hose reel mounting holes
20. Operator manuals

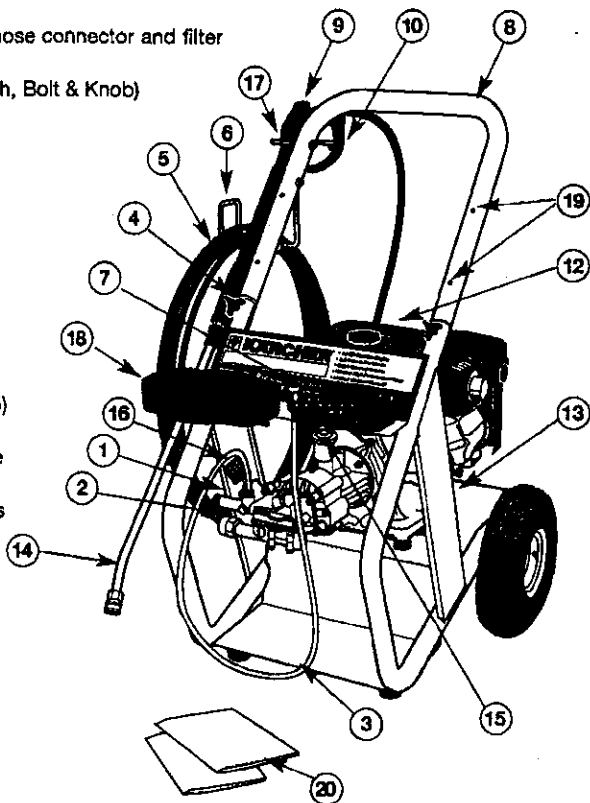

### Features:

- Thermal release valve

## NEVER!

- Never** point nozzle at people or animals.
- Never** drink alcohol or use drugs while operating this equipment.
- Never** spray electrical connections, electrical outlets or fixtures.
- Never** add fuel with the engine running or operate where fuel has been spilled.
- Never** touch hot surfaces or allow accessories to contact hot surfaces.
- Never** operate in an enclosed space, exhaust fumes are dangerous.
- Never** operate near utilities with open flames.
- Never** operate pressure washer without the water turned on.
- Never** use hot water.

## IMPORTANT PRECAUTIONS - Read First!

### ⚠ Safety Warnings

When using this product, basic precautions should always be followed:

- Read all the instructions before using the product.
- Fire hazard! Do not add fuel with the engine running. Do not operate if fuel has been spilled. Instead, move the machine to a different location and avoid creating sparks.
- Operate and fuel machine in a well ventilated area, free of devices featuring an open pilot or flame such as boilers, water heaters, etc.
- High pressure jets can be dangerous if subject to misuse. The jet must not be directed at persons, animals, electrical devices, or the machine itself.
- Wear safety goggles. 
- Do not use acids, alkalines, solvents, or any flammable material in this product. These products can cause physical injuries to the operator and irreversible damage to the machine.
- The machine has hot surfaces which can cause burns. Operate the unit in a safe environment and away from children.
- Do not allow the high pressure hose to come into contact with the muffler guard.
- Do not leave the machine running unattended.
- Learn how to stop the machine and release pressure quickly. Be thoroughly familiar with the controls.
- Stay alert — watch what you are doing.
- Do not operate the product when fatigued or under the influence of alcohol or drugs.
- Do not stand on unstable surfaces. Stand with both feet balanced at all times.
- Avoid tipping the machine on its side.
- The Gun Safety Lock PREVENTS the trigger from accidentally being engaged. This safety feature DOES NOT lock trigger in the on position.

### Water Supply (Cold Water Only)

- Water hose must be at least 3/4 inch in diameter.
- Flow rate of water supply must not fall below 3.5 GPM (gallons per minute).
- Flow rate can be determined by running the water for one minute into an empty 5-gallon container.
- The water supply temperature must not exceed 104°F/40°C.
- Never use the pressure washer to draw in water contaminated with solvents, e.g. paint thinners, gasoline, oil, etc.
- Always prevent debris from being drawn into the unit by using a clean water source.

We strongly recommend that this high pressure washer not be left running for periods of 5 minutes or longer without the trigger gun being engaged.

This Kärcher high pressure washer is equipped with thermal protection to extend the life of your pressure washer. The thermal protector will automatically activate at a predetermined high temperature ejecting hot water before resetting. This ensures that the pump does not become damaged.

### ⚠ Caution

- Follow the maintenance instructions specified in the manual.
- This machine has been designed for use with cleaning detergents supplied or recommended by the manufacturer. The use of other cleaning detergents may affect the operation of the machine and void the warranty.

## ASSEMBLY INSTRUCTIONS

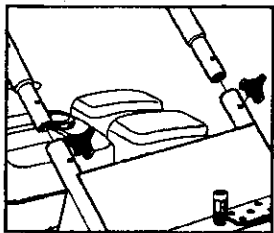

**Step 1** Attach the handle to the frame of the pressure washer. Align holes, insert bolts, and tighten with knobs.

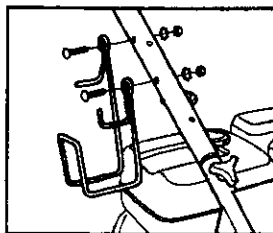

**Step 2** Attach the gun/hose storage handle.

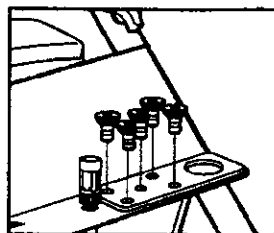

**Step 3** Place the quick connect nozzles in the nozzle holder.

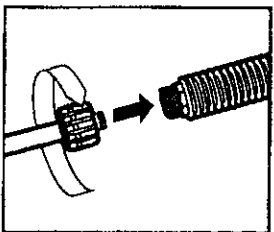

**Step 4** Attach the wand to the spray gun.

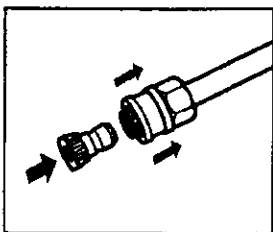

**Step 5** Pull the spring-loaded collar of the wand back to insert your choice of quick connect nozzle.

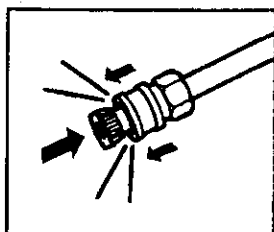

**Step 6** Release the collar and push the nozzle until the collar clicks. Pull the nozzle to make sure it is seated properly.

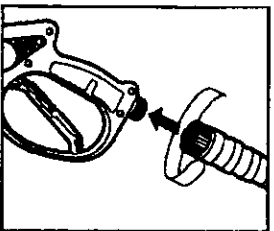

**Step 7** Attach the high pressure hose to the spray gun.

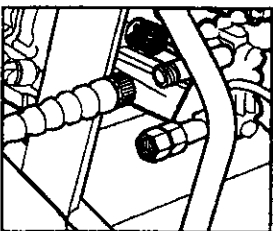

**Step 8** Connect the high pressure hose to the unit's high pressure outlet.

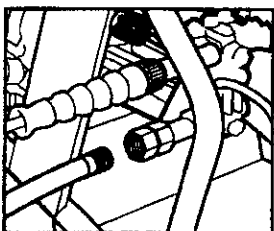

**Step 9** Connect the garden hose to unit's water inlet.

**Important!** Do not run the engine with a high or low oil level as this can cause engine damage. If you have further questions regarding the engine, please refer to the engine's operating manual included with the unit.

**You are now ready to operate your Kärcher Pressure Washer**

## OPERATING INSTRUCTIONS

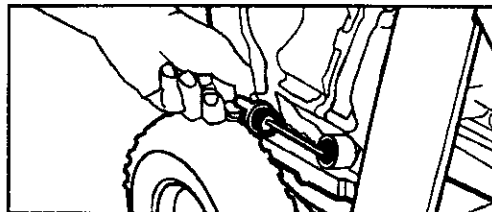

**Step 1** Check oil level. Oil level should be level with the bottom of the oil filler neck. Be sure the machine is level when checking the oil level. (Refer to the engine's operating manual for seasonal grades.)

We recommend that the oil be changed after the first 5 hours of use, then once every 50 hours.



**Step 2** Fill gas tank with unleaded gasoline. Do not use leaded gasoline.

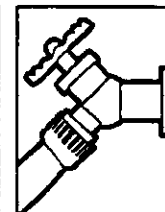

**Step 3** Connect garden hose to the cold water source and turn water on completely. **Never use hot water.**

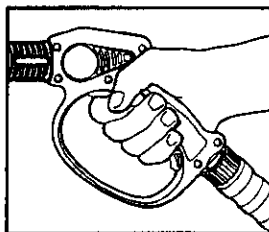

**Step 4** Trigger the gun to eliminate trapped air, wait for a steady flow of water to emerge from the spray nozzle.

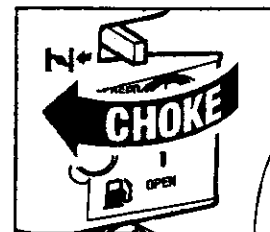

**Step 5** Slide the choke lever to the "CLOSED" position (on a warm engine, leave the choke lever in the open position).

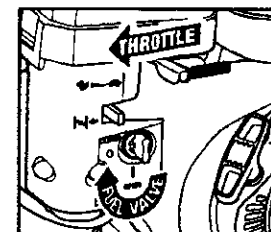

**Step 6 Model HD 2701** Turn the fuel valve to the "ON" position. Slide the throttle lever left about 1/3 of the way toward the fast position.

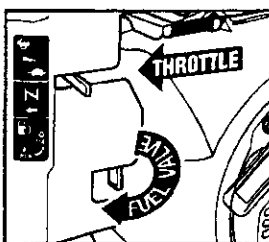

**Step 6 Model HD 3101** Slide the fuel valve to the "ON" position. Slide the throttle lever left about 1/3 of the way toward the fast position.

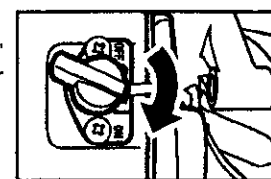

**Step 7** Turn the engine switch to the "ON" position.

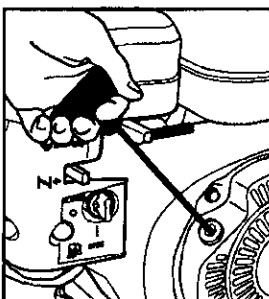

**Step 8** Pull the starter handle. If the engine fails to start after 3 pulls, squeeze the trigger gun to release pressure, and repeat step.

After the engine is warm and running smoothly, slide the choke lever to the right (open) and throttle to the left (fast).

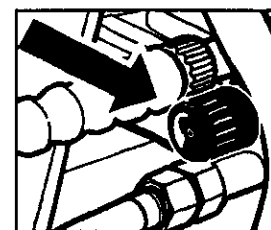

**Step 9** Adjust pressure control to desired setting.

## USING THE ACCESSORIES

The five color-coded quick connect nozzles provide a wide array of spray widths from 0° to 65° and are easily accessible when placed in the convenient rubber nozzle holder, which is provided on the front of the machine.

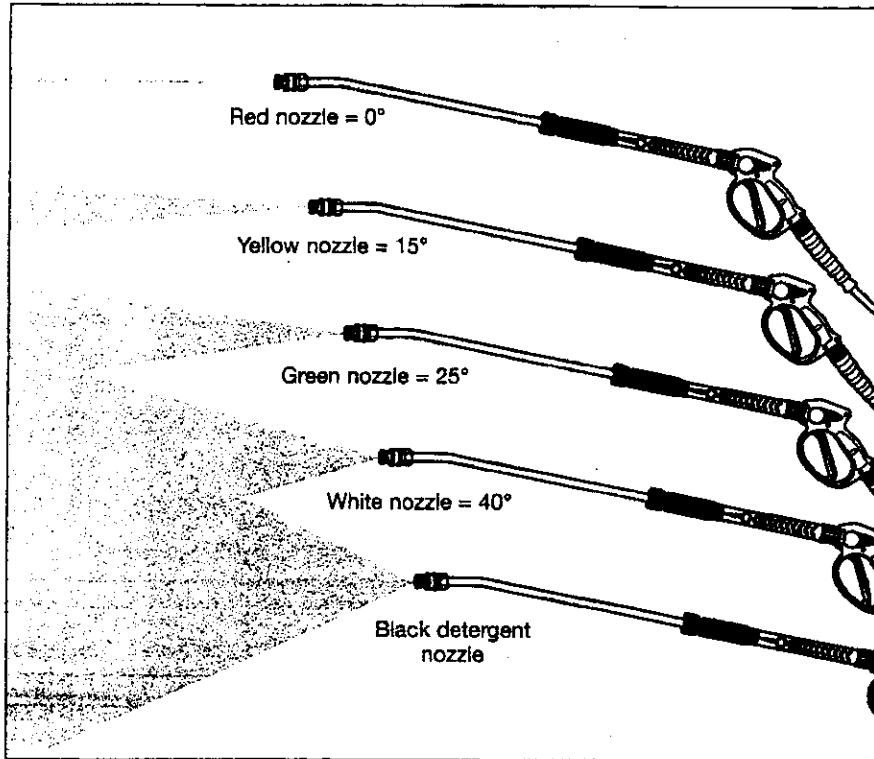

### WARNING

TO AVOID SERIOUS INJURY, NEVER POINT SPRAY NOZZLE AT YOURSELF, OTHER PERSONS OR ANIMALS.

## WORKING WITH DETERGENTS

Detergents can only be applied with the black nozzle.

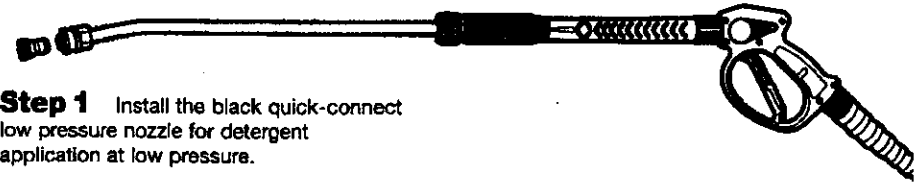

**Step 1** Install the black quick-connect low pressure nozzle for detergent application at low pressure.

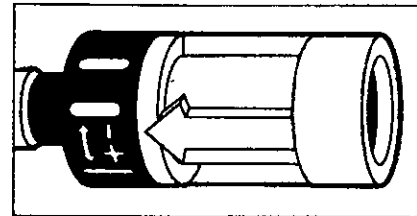

**Step 2** Adjust the filter end of the detergent tube for light (-), or maximum (+) detergent coverage.

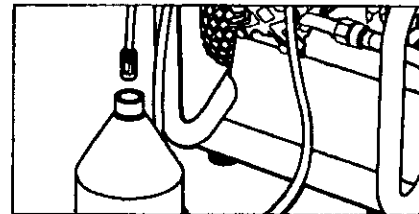

**Step 3** Fill a container with Kärcher detergent. Place the filter end of detergent suction tube into the detergent.

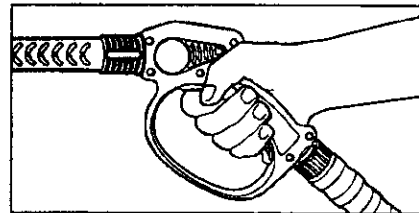

**Step 4** With the engine running, pull trigger to operate unit. Liquid detergent is drawn into the unit and mixed with water. Apply detergent to work area. Do not allow detergent to dry on surface.

For best results see *Cleaning Tips* on pages 8 & 9 or included *cleaning guide* for specific information on how to clean different surfaces.

### Always Use Kärcher Detergents for Best Results.

Kärcher biodegradable detergents are specially formulated to protect the environment and your pressure washer. The special formula won't clog the suction tube filter and will protect the internal parts of the pressure washer for a longer life. For Kärcher Detergents, check your retailer or call:

In USA Call:  
1-800-537-4129  
or visit our website:  
[www.karcher-usa.com](http://www.karcher-usa.com)

The following Kärcher detergents are available:

LIQUIDS (ready to use)	TABLETS (concentrated)
Vehicle Wash	All Purpose
House Wash	Degreaser
Degreaser	Deck and Patio
Deck Wash	Windows and Siding
All Purpose Cleaner	
Vehicle Wax	

### Caution

Never use:

- Bleach, Chlorine products and other corrosive chemicals
- Liquids containing solvents (i.e., paint thinners, gasoline, oils)
- Tri-sodium phosphate products
- Ammonia products
- Acid-based products

These chemicals will harm the unit and will damage the surface being cleaned.

## SHUTTING DOWN & CLEAN-UP

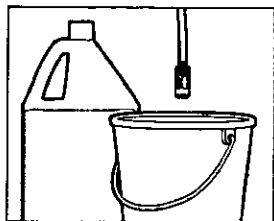

**Step 1** Remove detergent suction tube from container and insert into one gallon of fresh water. Siphon water at low pressure for one minute.

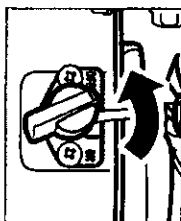

**Step 2** Turn off the engine.



**Step 3**  
HD2701 – turn fuel valve to the “OFF” position.  
HD3101 – turn fuel valve to the “OFF” position.

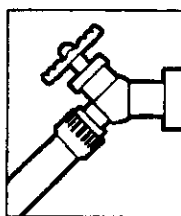

**Step 4** Turn off water supply.

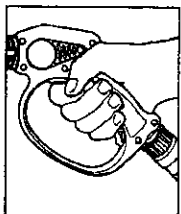

**Step 5** Press trigger to release water pressure.

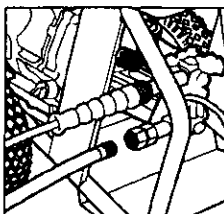

**Step 6** Disconnect garden hose from water inlet on the unit.

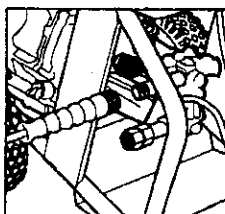

**Step 7** Disconnect high pressure hose from high pressure outlet.

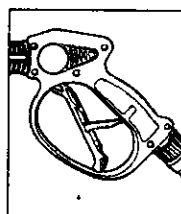

**Step 8** Engage the gun safety lock.

## TAKING A BREAK... five minutes or more

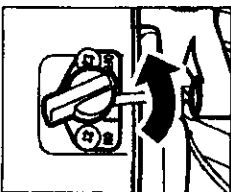

**Step 1** Turn off the engine.



**Step 2**  
HD2701 – turn fuel valve to the “OFF” position.  
HD3101 – turn fuel valve to the “OFF” position.

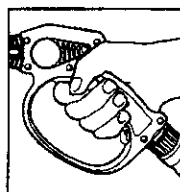

**Step 3** Press trigger to release water pressure.

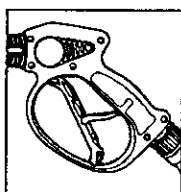

**Step 4** Engage gun safety lock.

## WINTERIZING AND LONG-TERM STORAGE

1. Disconnect all water connections.
2. Start the machine for a few seconds, until the remaining water exits. Turn off immediately.
3. Drain the gas and oil from the engine.
4. Do not allow high pressure hose to become kinked.

5. Store the machine and accessories in a room which does not reach freezing temperatures.

**Caution:** Failure to follow the above directions will result in damage to the pump assembly and accessories.

## CLEANING TIPS

### Deck Cleaning

(with or without detergent)

Pre-rinse deck and surrounding area with fresh water. If using Kärcher Deck and Patio Cleaner, place detergent suction tube directly into cleaning solution and apply to surface at low pressure. For best results, limit your work area to smaller sections of approximately 25 square feet. Allow Kärcher Deck and Patio Cleaner to remain on surface 1-3 minutes. Do not allow detergent to dry on surface. Rinse at high pressure in a long sweeping motion keeping the spray nozzle approximately 3-6 inches from the cleaning surface. Always clean from top to bottom and from left to right. When moving on to a new section of the cleaning surface, be sure to overlap the previous section to eliminate stop marks and ensure a more even cleaning result.

### Cement Patios, Brick and Stone

(with or without detergent)

Pre-rinse cleaning surface with fresh water. If using Kärcher Deck and Patio or All Purpose Cleaner, place detergent suction tube directly into cleaning solution and apply to surface at low pressure. For best results, limit your work area to smaller sections of approximately 25 square feet. Allow Kärcher Deck and Patio or All Purpose Cleaner to remain on surface 1-3 minutes. Do not allow detergent to dry on surface. Rinse at high pressure in a sweeping motion keeping the spray nozzle approximately 3-6 inches from the cleaning surface. Always clean from top to bottom and from left to right.

### Cars, Boats & Motorcycles

(with or without detergent)

Pre-rinse vehicle with fresh water. If using Kärcher Vehicle or All Purpose Cleaner, place detergent suction tube directly into cleaning solution and apply to surface at low pressure. For best results, clean one side of vehicle at a time and always apply detergent from bottom to top, do not allow detergent to dry on surface. If needed, use special Wash Brush Attachment to remove stubborn dirt. Rinse at high pressure in a sweeping motion keeping the spray nozzle approximately 6-8 inches from the cleaning surface (distance should increase when rinsing pin-striping or other sensitive surfaces). Always clean from top to bottom and from left to right. For best results, wipe surface dry with a chamois or soft dry cloth.

### House Siding

(with or without detergent)

Pre-rinse cleaning surface with fresh water. If using Kärcher House or Window and Siding Cleaner, place detergent suction tube directly into cleaning solution and apply to surface at low pressure (for best results, limit your work area to sections of approximately 6 feet and always apply detergent from bottom to top). Allow Kärcher House or Window and Siding Cleaner to remain on surface 1-3 minutes. Do not allow detergent to dry on surface, if surface appears to be drying, simply wet down surface with fresh water. If needed, use special Wash Brush Attachment to remove stubborn dirt. Rinse at high pressure from top to bottom in an even sweeping motion keeping the spray nozzle approximately 6 inches from the cleaning surface.

## CLEANING TIPS - continued

### Barbeque Grills, Outdoor Power Equipment & Gardening Tools

(with or without detergent)

Pre-rinse cleaning surface with fresh water. If using Kärcher All Purpose Cleaner or Degreaser, place detergent suction tube directly into cleaning solution and apply detergent at low pressure. Allow Kärcher detergent to remain on surface 1-3 minutes. Do not allow detergent to dry on surface. Rinse at high pressure keeping the spray nozzle approximately 3-6 inches from the cleaning surface. For removing extremely stubborn dirt, it may be necessary to move the spray nozzle even closer to the surface for greater dirt cutting action. To remove caked on mud from garbage cans, lawn mower blades, wheelbarrows or other non-sensitive metal surfaces, you may want to use the Kärcher Dirtblaster® Nozzle.

**Caution: Do not use Dirtblaster® spray nozzle on cloth, plastic or other sensitive surfaces as it may cause damage.**

### Patio & Lawn Furniture

(with or without detergent)

Pre-rinse furniture and surrounding area with fresh water. If using Kärcher All Purpose Cleaner, place detergent suction tube directly into cleaning solution and apply to surface at low pressure. Allow Kärcher All Purpose Cleaner to remain on surface 1-3 minutes. Do not allow detergent to dry on surface. Rinse at high pressure in a sweeping motion keeping the spray nozzle approximately 3-6 inches from the cleaning surface. For best results, clean from top to bottom and from left to right.

**Caution: Do not use Dirtblaster® nozzle on patio or lawn furniture as it may cause damage.**

### Recommendations

- Before cleaning any surface an inconspicuous area should be cleaned to test spray pattern and distance for maximum cleaning results.
- If painted surfaces are peeling or chipping, use extreme caution as pressure washer may remove the loose paint from the surface.

## OPTIONAL CLEANING ACCESSORIES

Optional cleaning accessories are available to further enhance your cleaning capabilities. See accessories order form for product descriptions and ordering instructions.

- Dirtblaster® nozzle
- Extension Wand 80"
- Rotating Wash Brush
- Sand Blasting Attachment
- Hose Reel
- Pipe Drain Cleaner
- Extension Hose 30'
- Surface Cleaner
- Wash Brush

## TROUBLESHOOTING

Symptom	Cause	Solution
Engine will not start.	No gasoline.	Fill gas tank.
	Fuel valve is in "OFF" position.	Slide the fuel valve lever to "ON" position.
	Engine throttle is not in correct position.	Slide the throttle left 1/3 of the way to the fast position.
	Choke is not in correct position.	Slide choke lever left to "CLOSED" position.
	Pressure built up in the high pressure washer.	Squeeze the trigger to release the pressure.
	Engine switch in "OFF" position.	Turn engine switch "ON".
Unit does not reach high pressure.	Diameter of garden hose is too small.	Replace with a 3/4 inch garden hose.
	Water supply is restricted.	Check garden hose for kinks, leaks and blockage.
	Not enough inlet water supply.	Open water source full force.
	Water inlet filter is clogged.	Remove filter and rinse out in warm water.
	Pump pressure control is in low pressure position.	Turn pump pressure control to high pressure position.
	Black detergent nozzle is attached.	Remove black detergent nozzle and attach a high pressure nozzle.
Output pressure varies high and low.	Not enough inlet water supply.	Turn water on full force. Check garden hose for kinks, leaks or blockage.
	Pump is sucking air.	Check that hoses and fittings are air tight. Turn off machine and purge pump by squeezing trigger gun until a steady flow of water emerges through the nozzle.
	Water inlet filter is clogged.	Remove filter and rinse out in warm water.
	Discharge nozzle is obstructed.	Blow out or remove debris with a fine needle.
	Calcified gun, hose or spray wand.	Run distilled vinegar through detergent suction tube.

## TROUBLESHOOTING – continued

Symptom	Cause	Solution
No detergent.	Detergent suction tube not properly connected to the machine.	Check connection.
	Detergent is too thick.	Dilute detergent. For best results, use Kärcher detergent.
	Detergent filter valve is at lowest setting.	Set detergent filter valve to a higher setting.
	Filter on detergent suction tube is clogged.	Run warm water through filter to remove debris.
	Damaged or clogged detergent suction tube.	Remove obstruction or replace detergent suction tube.
	A high pressure nozzle is attached.	Replace with black detergent nozzle.
	Discharge nozzle is obstructed.	Blow out or remove debris with fine needle.
Garden hose connection leaks.	Loose fittings.	Tighten fittings.
	Missing/worn rubber washer.	Insert new washer.
Spray wand leaks.	Spray wand not properly attached.	Slide the spray wand into the gun. Turn the wand collar clockwise onto the gun threads until tight.
	Broken o-ring.	Call Kärcher customer service hotline and order an o-ring.
Pump is noisy.	Pump is sucking air.	Check that hoses and fittings are air tight. Turn off machine and purge pump by squeezing trigger gun until a steady flow of water emerges through the nozzle.
Water leaks from pump.	Loose fittings.	Check that all fittings are tight.
	Water seals are damaged or worn.	Call service center.
	Thermal protection device is activated.	Thermal protection device will auto reset.
Oil Drip.	Oil seals are damaged or worn.	Call service center.

In USA Call:  
**1-800-537-4129**  
 or visit our website: [www.karcher-usa.com](http://www.karcher-usa.com)

If you encounter any additional difficulties not listed, please call our service center for help.