

---

**powerworks™**

**1700 PSI / 1.4 GPM  
ELECTRIC PRESSURE WASHER  
51102**

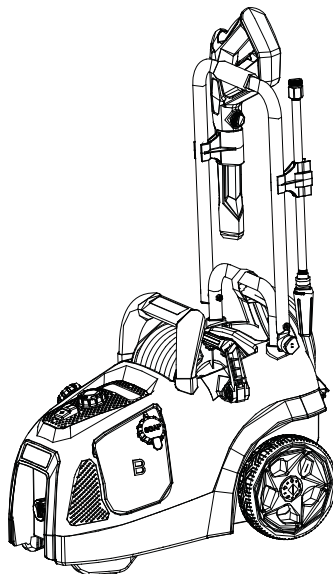

**OPERATOR'S MANUAL**

**TOLL-FREE HELPLINE: 1-888-90WORKS (888.909.6757)**

---

**⚠** Read all safety rules and instructions carefully before operating this tool.

# TABLE OF CONTENTS

---

Introduction.....	2
Important Safety Instructions.....	3
Specific Safety Rules.....	4-5
Symbols.....	6-7
Electrical.....	8-9
Know Your Pressure Washer.....	10
Assembly.....	11-14
Operation.....	15-20
Maintenance.....	21-23
Troubleshooting.....	24-26
Warranty.....	27
Exploded View.....	28
Part List.....	29-31

# PRODUCT SPECIFICATIONS

---

Induction Motor.....	120 V, 60 Hz, 13 Amps, 3-Wire
Max. Pounds Per Square Inch Pressure*.....	1700 psi
Rated Gallons Per Minute*.....	1.4 gpm
Cleaning Units.....	2380 C.U
Maximum Inlet Water Temperature.....	104°F
Unit Weight.....	 3lbs (18.3 kg)



# IMPORTANT SAFETY INSTRUCTIONS

---

## **W A R N I N G**

**Read and understand all instructions.** Failure to follow all instructions listed below may result in electric shock, fire, and/or serious personal injury.

---

## **W A R N I N G**

When using this product basic precautions should always be followed, including the following:

---

### **READ ALL INSTRUCTIONS BEFORE USING THIS PRODUCT**

- **To reduce the risk of injury**, close supervision is necessary when a product is used near children.
  - **Be thoroughly familiar with controls.** Know how to stop the product and release pressure quickly.
  - **Stay alert and exercise control.** Watch what you are doing and use common sense. Do not operate product when you are tired. Do not rush.
  - **Do not operate the product while under the influence of drugs, alcohol, or any medication.**
  - **Keep the area of operation clear of all persons**, particularly small children, and pets.
  - **Don't overreach or stand on unstable support.** Keep proper footing and balance at all times.
  - **Follow the maintenance instructions specified in this manual.**
  - **This product is provided with a ground fault circuit interrupter built into the power cord plug.** If replacement of the plug or cord is needed, use only identical replacement parts.
- 

## **W A R N I N G**

**Risk of injection or injury** – Do not direct discharge stream at people or animals.

---

### **GROUND FAULT CIRCUIT INTERRUPTER PROTECTION**

- This pressure washer is provided with a ground fault circuit interrupter (GFCI) built into the plug of the power supply cord. This device provides additional protection from the risk of electric shock. Should replacement of the plug or cord become necessary, use only identical replacement parts that include GFCI protection.

### **SERVICING OF A DOUBLE-INSULATED APPLIANCE**

- In a double-insulated product, two systems of insulation are provided instead of grounding. No grounding means is provided on a double-insulated product, nor should a means for grounding be added to the product. Servicing a double-insulated product requires extreme care and knowledge of the system, and should be done only by qualified service personnel. Replacement parts for a double insulated product must be identical to the parts they replace. A double-insulated product is marked with the words "DOUBLE INSULATION" or "DOUBLE INSULATED." The symbol  may also be marked on the product.

### **EXTENSION CORDS**

- Do not use with extension cord. Plug directly into receptacle.
- 

## **W A R N I N G**

To reduce the risk of electrocution, keep all connections dry and off the ground. Do not touch plug with wet hands.

---

# SPECIFIC SAFETY RULES

---

- **Know your product.** Read the operator's manual carefully. Learn the machine's applications and limitations as well as the specific potential hazards related to this product.
- **To reduce the risk of injury,** keep children and visitors away. All visitors should wear safety glasses and be kept a safe distance from work area.
- **Use right product.** Don't force product or attachment to do a job it was not designed for. Don't use it for a purpose not intended.
- **Dress properly.** Do not wear loose clothing, gloves, neckties, or jewelry. They can get caught and draw you into moving parts. Rubber gloves and nonskid footwear are recommended when working outdoors. Also wear protective hair covering to contain long hair.
- **Do not operate the equipment while barefoot or when wearing sandals or similar lightweight footwear.** Wear protective footwear that will protect your feet and improve your footing on slippery surfaces.
- **Exercise caution to avoid slipping or falling.**
- **Always wear eye protection with side shields marked to comply with ANSI Z87.1.** Following this rule will reduce the risk of serious personal injury.
- **Use only recommended accessories.** The use of improper accessories may cause risk of injury.
- **Check damaged parts.** Before further use of the product, a guard or other part that is damaged should be carefully checked to determine that it will operate properly and perform its intended function. Check for alignment of moving parts, binding of moving parts, breakage of parts, mounting, and any other conditions that may affect its operation. A guard or other part that is damaged must be properly repaired or replaced by an authorized service center to avoid risk of personal injury.
- **Never leave product running unattended.** Turn power off. Don't leave product until it comes to a complete stop.
- **Keep the motor free of grass, leaves,** or grease to reduce the chance of a fire hazard.
- **Follow manufacturer's recommendations for safe loading, unloading, transport, and storage of machine.**
- **Keep product dry, clean, and free from oil and grease.** Always use a clean cloth when cleaning. Never use brake fluids, gasoline, petroleum-based products, or any solvents to clean product.
- **Check the work area before each use.** Remove all objects such as rocks, broken glass, nails, wire, or string which can be thrown or become entangled in the machine.
- **Do not use product if switch does not turn it off.** Have defective switches replaced by an authorized service center.
- **Avoid dangerous environment.** Don't expose to rain. Keep work area well lit.
- **Do not abuse the cord.** Never use the cord to carry the product or to disconnect the plug from an outlet. Keep cord away from heat, oil, sharp edges, or moving parts. Replace damaged cords immediately. Damaged cords increase the risk of electric shock.
- **Ground Fault Circuit Interrupter (GFCI) protection should be provided on the circuit(s) or outlet(s) to be used for the product.** Receptacles are available having built-in GFCI protection and may be used for this measure of safety.
- **Never direct a water stream toward people or pets, or any electrical device.**
- **Before starting any cleaning operation,** close doors and windows. Clear the area to be cleaned of debris, toys, outdoor furniture, or other objects that could create a hazard.
- **Do not use acids, alkalines, solvents, flammable material, bleaches, or industrial grade solutions** in this product. These products can cause physical injuries to the operator and irreversible damage to the machine.

# SPECIFIC SAFETY RULES

---

## **W A R N I N G**

**High pressure jets can be dangerous if subject to misuse.** The jet must not be directed at people, animals, electrical devices, or the machine itself.

---

- **Keep the motor away from flammables and other hazardous materials.**
  - **Check bolts and nuts** for looseness before each use. A loose bolt or nut may cause serious motor problems.
  - **Before storing**, allow the motor to cool.
  - **When servicing use only identical replacement parts.** Use of any other parts may create a hazard or cause product damage.
  - **ONLY** use cold water.
  - **Make sure minimum clearance** of 3 feet is maintained from combustible materials.
  - **Connect pressure washer only to an individual branch circuit.**
  - **Hold the handle and wand securely with both hands.** Expect the trigger handle to move when the trigger is pulled due to reaction forces. Failure to do so could cause loss of control and injury to yourself and others.
  - **Save these instructions.** Refer to them frequently and use them to instruct other users. If you loan someone this product, loan them these instructions also.
- 

## **W A R N I N G**

Some dust created by power sanding, sawing, grinding, drilling, and other construction activities contains chemicals known to cause cancer, birth defects or other reproductive harm. Some examples of these chemicals are:









- Lead from lead-based paints
  - Crystalline silica from bricks and cement and other masonry products
  - Arsenic and chromium from chemically-treated lumber. Your risk from these exposures varies, depending on how often you do this type of work. To reduce your exposure to these chemicals: work in a well ventilated area, and work with approved safety equipment, such as those dust masks that are specially designed to filter out microscopic particles.
- 

**SAVE THESE INSTRUCTIONS**

---

# SYMBOLS

Some of the following symbols may be used on this product. Please study them and learn their meaning. Proper interpretation of these symbols will allow you to operate the product better and safer.



SYMBOL	NAME	DESIGNATION/EXPLANATION
V	Volts	Voltage
A	Amperes	Current
Hz	Hertz	Frequency (cycles per second)
W	Watt	Power
no	No Load Speed	Rotational speed, at no load
~	Alternating Current	Type of current
.../min	Per Minute	Revolutions, strokes, surface speed, orbits etc., per minute
	Class II Construction	Double-insulated construction
	Safety Alert	Indicates a potential personal injury hazard.
	Read Operator's Manual	To reduce the risk of injury, user must read and understand operator's manual before using this product.
	Eye Protection	Always wear eye protection with side shields marked to comply with ANSI Z87.1.
	Wet Conditions Alert	Do not expose to rain or use in damp locations.
	Risk of Injection	To reduce the risk of injection or injury, never direct a water stream towards people or pets or place any body part in the stream. Leaking hoses and fittings are also capable of causing injection injury. Do not hold hoses or fittings.
	Kickback	To reduce the risk of injury from kickback, hold the spray wand securely with both hands when the machine is on.
	Electric Shock	Failure to use in dry conditions and to observe safe practices can result in electric shock.

# SYMBOLS

---

SYMBOL	NAME	DESIGNATION/EXPLANATION
	Chemical Burns	To reduce the risk of injury or damage, DO NOT USE ACIDS, ALKALINES, BLEACHES, SOLVENTS, FLAMMABLE MATERIAL, OR INDUSTRIAL GRADE SOLUTIONS in this product.

The following signal words and meanings are intended to explain the levels of risk associated with this product.

SYMBOL	SIGNAL	MEANING
	<b>DANGER</b>	Indicates an imminently hazardous situation, which, if not avoided, will result in death or serious injury.
	<b>WARNING</b>	Indicates a potentially hazardous situation, which, if not avoided, could result in death or serious injury.
	<b>CAUTION</b>	Indicates a potentially hazardous situation, which, if not avoided, may result in minor or moderate injury.
	<b>CAUTION</b>	(Without Safety Alert Symbol) Indicates a situation that may result in property damage.

## SERVICE

Servicing requires extreme care and knowledge and should be performed only by a qualified service technician. For service we suggest you return the product to your nearest **AUTHORIZED SERVICE CENTER** for repair. When servicing, use only identical replacement parts.

---

### **W A R N I N G**

To avoid serious personal injury, do not attempt to use this product until you read thoroughly and understand completely the operator's manual. If you do not understand the warnings and instructions in the operator's manual, do not use this product. Call GREENWORKS customer service for assistance.

---

### **W A R N I N G**



The operation of any power tool can result in foreign objects being thrown into your eyes, which can result in severe eye damage. Before beginning power tool operation, always wear safety goggles or safety glasses with side shields and, when needed, a full face shield. We recommend Wide Vision Safety Mask for use over eyeglasses or standard safety glasses with side shields. Always use eye protection which is marked to comply with ANSI Z87.1.

# ELECTRICAL

---

## **⚠ WARNING**

The double insulated system is intended to protect the user from shock resulting from a break in the product's internal insulation. Observe all normal safety precautions to avoid electrical shock.

---

## **DOUBLE INSULATED**

Double insulation is a concept in safety in electric power tools, which eliminates the need for the usual three-wire grounded power cord. All exposed metal parts are isolated from the internal metal motor components with protecting insulation. Double insulated products do not need to be grounded.

*NOTE: Servicing of a product with double insulation requires extreme care and knowledge of the system and should be performed only by a qualified service technician. For service, we suggest you return the product to your nearest authorized service center for repair. Always use original factory replacement parts when servicing.*

## **ELECTRICAL CONNECTION**

This product has a precision-built electric motor. It should be connected to a power supply that is 120 volts, AC only (normal household current), 60 Hz. Do not operate this product on direct current (DC). A substantial voltage drop will cause a loss of power and the motor will overheat. If the product does not operate when plugged into an outlet, double-check the power supply.

## **DRIP LOOP (See Figure 1.)**

To prevent water from flowing along the power cable, and possibly reaching the electrical outlet and plug, we recommend using a simple drip loop as shown below.

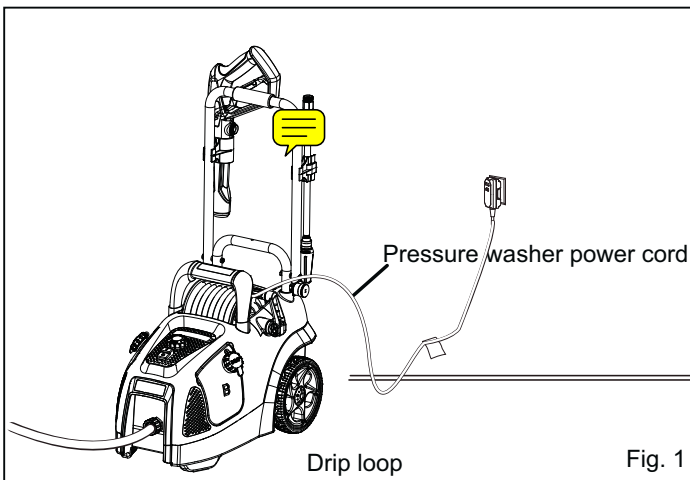



# ELECTRICAL

---

---

## **⚠ WARNING**

Keep the cord clear of the working area. Position the cord so that it will not get caught on lumber, tools, or other obstructions while you are working with a power tool. Failure to do so can result in serious personal injury.

---

---

## **⚠ WARNING**

Double insulation is a concept in safety in electric power tools, which eliminates the need for the usual three-wire grounded power cord. All exposed metal parts are isolated from the internal metal motor components with protecting insulation. Double insulated products do not need to be grounded.

---

## **GROUND FAULT CIRCUIT INTERRUPTER**

This unit is equipped with a Ground Fault Circuit Interrupter (GFCI), which guards against the hazards of ground fault currents. An example of ground fault current is the current that would flow through a person who is using an appliance with faulty insulation and, at the same time, is in contact with an electrical ground such as a plumbing fixture, wet floor, or earth.

GFCI plugs do not protect against short circuits, overloads, or shocks.

---

## **⚠ WARNING**

TO PROTECT AGAINST ELECTRIC SHOCK TEST BEFORE EACH USE

- PLUG INTO RECEPTACLE
- IF THE GFCI LIGHT IS NOT ON, PRESS THE RESET BUTTON, THE LIGHT SHOULD COME ON
- PRESS TEST BUTTON, LIGHT MUST GO OFF
- PRESS RESET BUTTON AGAIN FOR USE

DO NOT USE IF TEST FAILS

DO NOT USE AN EXTENSION CORD TO SUPPLY POWER TO THIS DEVICE

RAINPROOF

DO NOT IMMERSE

---

# KNOW YOUR PRESSURE WASHER

---

The safe use of this product requires an understanding of the information on the tool and in this operator's manual as well as a knowledge of the project you are attempting. Before use of this product, familiarize yourself with all operating features and safety rules. (See Figure 2.)

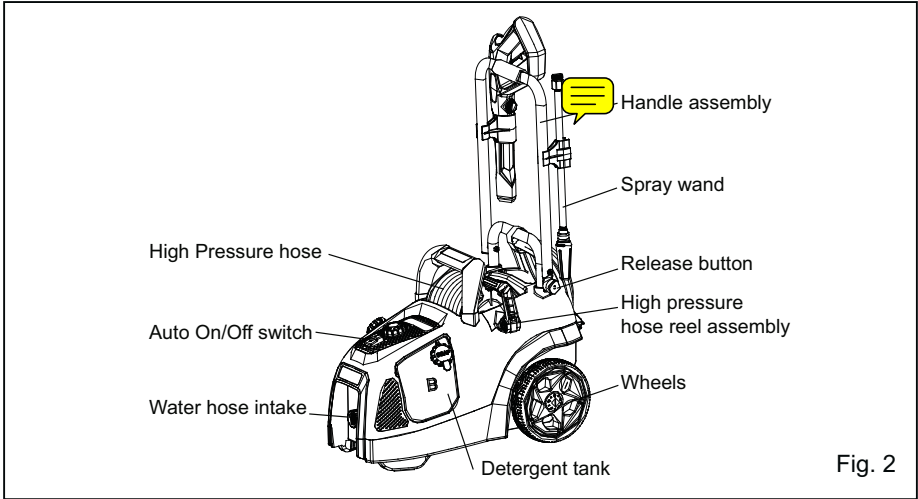

Fig. 2

## **DETERGENT TANK**

Remove the cap from the detergent tank to add detergent to the pressure washer.

## **GFCI PLUG**

The pressure washer is equipped with a GFCI plug to guard against the hazards of ground fault currents. This plug does not protect against short circuits, overloads, or shocks.

## **HIGH PRESSURE HOSE REEL ASSEMBLY**

A convenient hose reel stores the high pressure hose when the pressure washer is not in use.

## **AUTO ON/OFF SWITCH:**

This Pressure washer is equipped with an Auto Start/Stop feature. To operate: Press power switch On (I). Pump will pressurize and shut down immediately. Once the trigger of the gun is depressed the unit will turn on. Unit will shut off and be in standby mode when trigger is released.

## **POWER CORD STORAGE**

The power cord can be wrapped and stored with the hook and loop strap located on the lower handle.

## **FOLDING HANDLE**

The folding handle allows the handle to be lowered for convenient storage.

## **TRIGGER AND WAND ASSEMBLY**

The Trigger and Wand allows you to operate the pressure washer by depressing the trigger to activate the pump to spray water using the desired nozzle tip.

# ASSEMBLY

---

## UNPACKING

This product requires assembly.

- Carefully remove the product and any accessories from the box. Make sure that all items listed in the packing list are included.

---

## WARNING

Do not use this product if any parts on the Packing List are already assembled to your product when you unpack it. Parts on this list are not assembled to the product by the manufacturer and require customer installation. Use of a product that may have been improperly assembled could result in serious personal injury.

- Inspect the product carefully to make sure no breakage or damage occurred during shipping.
- Do not discard the packing material until you have carefully inspected and satisfactorily operated the product.
- If any parts are damaged or missing, please call 1-888-909-6757 for assistance.

---

PACKING LIST
• Pressure Washer with 25 ft. High Pressure Hose
• Operator's manual and Quick Start Guide
• Spray gun (Trigger)
• Lance (Wand)
• NOZZLES: Turbo nozzle (0°, 25°, 40°, black soap applicator)

---

## WARNING

If any parts are damaged or missing do not operate this product until the parts are replaced. Use of this product with damaged or missing parts could result in serious personal injury.

---

## WARNING

Do not attempt to modify this product or create accessories not recommended for use with this product. Any such alteration or modification is misuse and could result in a hazardous condition leading to possible serious personal injury.

---

## WARNING

Do not connect to power supply until assembly is complete. Failure to comply could result in accidental starting and possible serious personal injury.

---

# ASSEMBLY

---

## OPERATING THE HANDLE ASSEMBLY (See Figure 3.)

- Open for use: Lift up on the handle bar pivoting it towards the back into an upright position until it clicks and locks into place.
- To fold the handle, pull the latch sideways, and push the handle down and forward.

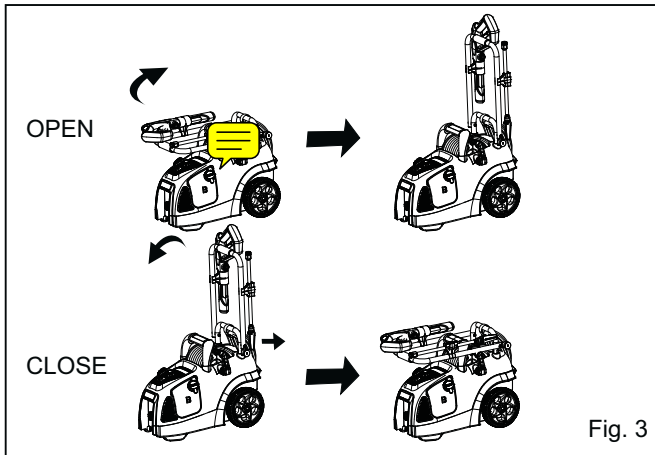

## ASSEMBLING THE SPRAY WAND (See Figure 4.)

- Push the end of the spray wand into the trigger handle and rotate clockwise to secure.
- Pull on the spray wand to be certain it is properly secured.

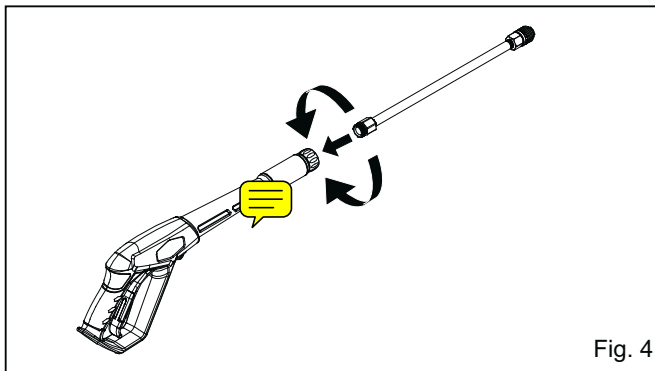

# ASSEMBLY

---

## CONNECTING HIGH PRESSURE HOSE TO TRIGGER HANDLE *(See Figure 5.)*

1. Align the pressure hose with the trigger handle and push up and into position. (Fig. 5.1)
2. With hose pushed into position on the trigger handle secure in place by turning the hose lock clockwise until fully tightened. (Fig 5.2)

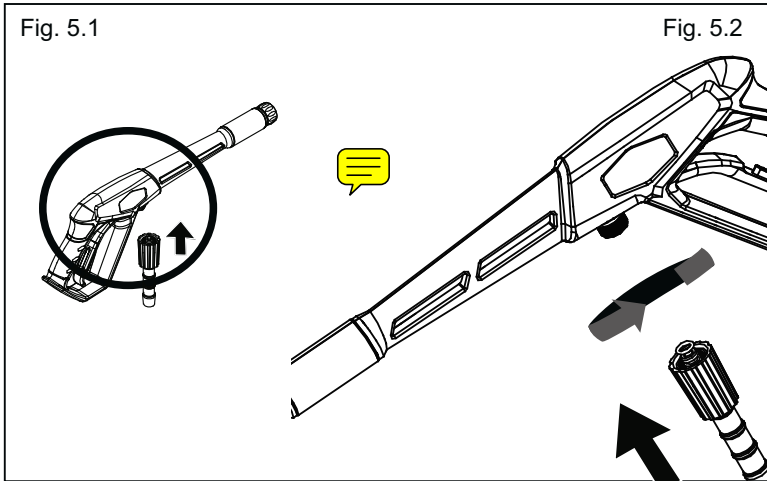

# ASSEMBLY

---

## CONNECTING THE GARDEN HOSE (See Figure 6.)

---

### CAUTION :

Always observe all local regulations when connecting hoses to the water main. Some areas have restrictions against connecting directly to public drinking water supply to prevent the feedback of chemicals into the drinking water supply. Direct connection through a receiver tank or backflow preventer is usually permitted.

---

- Uncoil the garden hose.

*NOTE: There must be a minimum of 10 feet of unrestricted garden hose between the water intake and the garden hose faucet or shut off valve (such as a "Y" shut off connector).*

- Run water through the garden hose for 120 seconds to clean any debris from the hose.
- Inspect the screen in the water intake.
- If the screen is damaged, do not use the machine until the screen has been replaced.
- If the screen is dirty, clean it before connecting the garden hose to the machine.
- With the hose faucet turned completely off, attach the end of the garden hose to the water intake. Tighten by hand only.

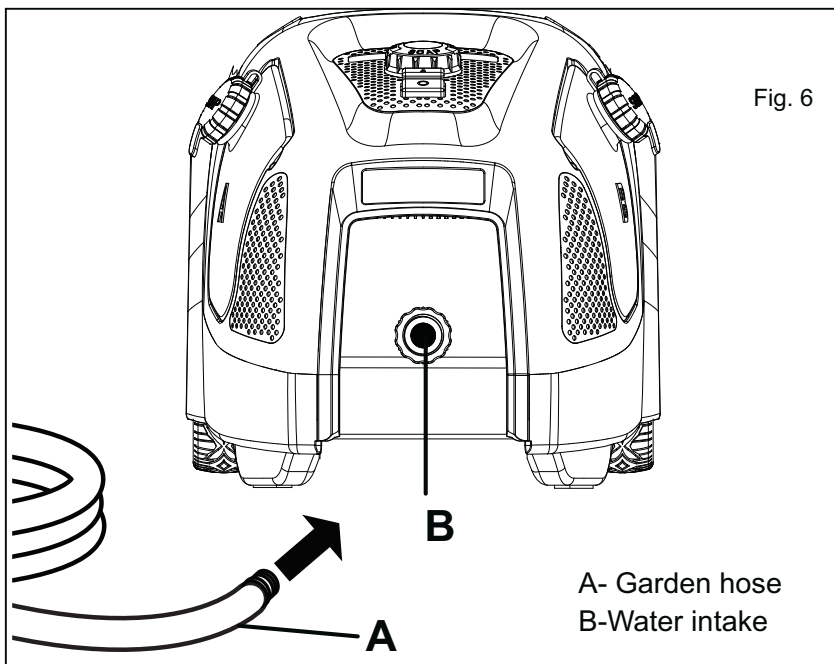

# OPERATION

---

---

## **⚠ WARNING**

Do not allow familiarity with the product to make you careless. Remember that a careless fraction of a second is sufficient to inflict serious injury.

---

---

## **⚠ WARNING**

Always wear eye protection with side shields marked to comply with ANSI Z87.1. Failure to do so could result in objects being thrown into your eyes resulting in possible serious injury.

---

---

## **⚠ WARNING**

Do not use any attachments or accessories not recommended by the manufacturer of this product. The use of attachments or accessories not recommended can result in serious personal injury.

---

---

## **⚠ WARNING**

Never direct a water stream toward people or pets, or any electrical device. Failure to heed this warning could result in serious injury.

---

## **APPLICATIONS**

You may use this product for the purposes listed below:

- Cleaning boats, cars, trucks, motorcycles, outdoor furniture, grills, house siding, driveways, patios and decks.

## **DETERGENT ADDING AND USE** (See *Figure 7-1.*)

Use only detergents designed for pressure washers; household detergents, acids, alkalines, bleaches, solvents, flammable material, or industrial grade solutions can damage the pump. Many detergents may require mixing prior to use. Prepare cleaning solution as instructed on the solution bottle.

## **SOAP APPLICATION**

Soap is applied under low pressure high volume for optimum performance  
Soap can not be applied under high pressure with this machine

# OPERATION

---

## To add:

- Place pressure washer upright on a flat surface
- Remove cap from detergent tank
- Pour detergent into tank

---

## **CAUTION**

Use only approved pressure washer cleaners. Do not use bleach, chlorine, or any cleaners containing acids.

---

## To use:

The dial is used to control the suction between detergent tanks and increase/decrease detergent flow.

- Turn dial to choose the desired tank. (See Figure 7-2.)
- Connect low pressure black soap nozzle to the wand connector. (See Figure 7-3.)
- Squeeze the trigger and the detergent will automatically be mixed with the water and dispensed from the nozzle.

*NOTE: Use a funnel, if needed, to prevent accidental spilling of the detergent outside the tank. If any detergent is spilled during the filling process, make sure the unit is cleaned and dried before proceeding.*

- Reinstall cap.

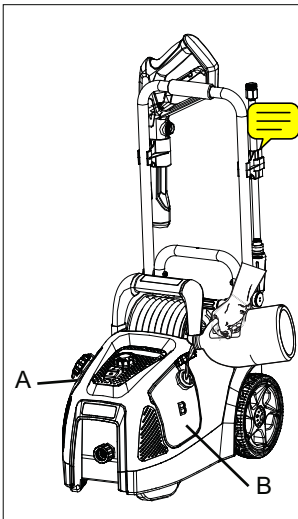

Fig. 7-1

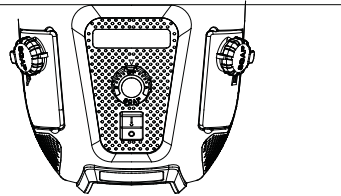

Fig. 7-2

Use SOAP tip only

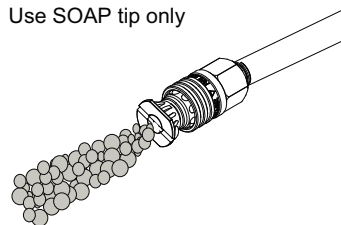

Fig. 7-3



# OPERATION

---

## STARTING AND STOPPING THE PRESSURE WASHER (See Figure 8.)

---

### CAUTION :

Do not run the pump without the water supply connected and turned on.

---

- Connect the garden hose.
  - Turn the garden hose on then squeeze the trigger and hold for 120 seconds to relieve air pressure. Once a steady stream of water appears, release the trigger.
- 

*NOTE: If the pressure washer pulsates and the water stream is intermittent turn the pressure washer off and continue to bleed air out of the system. Ensure to check that the garden hose is fully turned on and not kinked which could prevent air in the system and pulsating. This process could take minimum of 120 seconds or longer.*

---

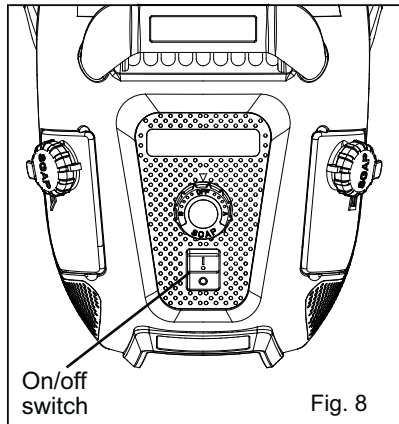

- After ensuring the On/Off switch is in the OFF ( O ) position, connect the pressure washer to the power supply.
  - Press the reset button on the pressure washer's plug to make sure the unit is ready for operation.
  - Press ON ( I ) on the switch to start the motor.
  - To stop the motor, release the trigger and press OFF( O ) on the switch.
- 

*NOTE: The pressure washer may be on and the system may have pressure even when the pump and/or motor cannot be heard running. Always use caution around the pressure washer.*

---

### **▲** WARNING

Hold the trigger handle securely with both hands. Expect the trigger handle to move when the trigger is pulled due to reaction forces. Failure to do so could cause loss of control and injury to yourself and others.

---

*NOTE: AUTO ON/OFF SWITCH: This Pressure washer is equipped with an Auto Start/Stop feature. To operate: Press power switch On (I). Pump will pressurize and shut down immediately. Once the trigger of the gun is depressed the unit will turn on. Unit will shut off and be in standby mode when trigger is released.*

---

# OPERATION



Soap is applied under low pressure high volume for optimum performance.  
 Soap cannot be applied under high pressure with this machine.

## USING THE NOZZLES (See Figure 9.)

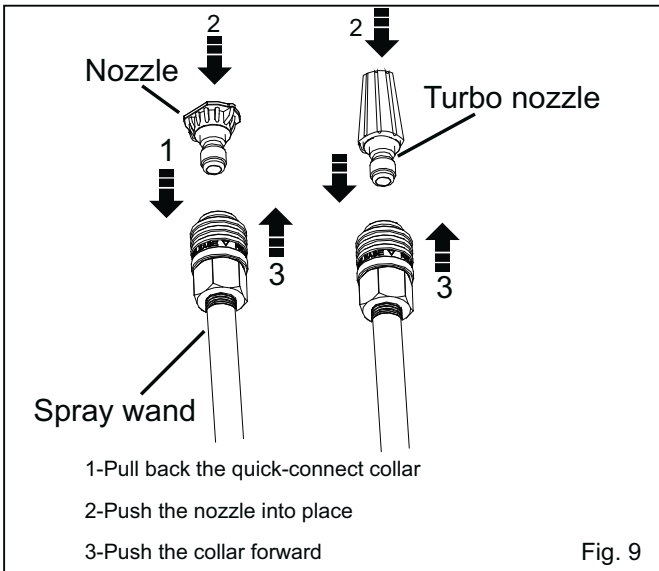

Each of the nozzles has a different spray pattern. Before starting any cleaning job, determine the best nozzle for the job. The following chart offers some general guidelines to help you choose the best nozzle for your application.

*NOTE: Always try nozzles in an inconspicuous area first.*



NOZZLE	APPLICATION
 <b>0°</b>	<b>Red - Stream nozzle (0° )</b> <ul style="list-style-type: none"> <li>The Red 0 degree tip provides a straight line of spray. It provides the highest amount of pressure. It is best used for removing hard, stuck-on grime or dirt.</li> </ul>
 <b>25°</b>	<b>Green - Narrow fan tip (25° )</b> <ul style="list-style-type: none"> <li>The Green pressure washer tip provides high versatility with its 25 degree angle tip. Referred to as the washing tip, because it provides adequate pressure to remove dirt from surfaces, but is designed to not damage many surfaces. This pressure washer tip is designed for "sweeping" foliage or debris given its wide angle. This tip is versatile due to its wide area of cleaning and strong pressure application.</li> </ul>

# OPERATION

NOZZLE	APPLICATION
 <p>40°</p>	<p><b>White - Wide fan tip (40°)</b></p> <ul style="list-style-type: none"> <li>The white 40 degree tip, referred to as the “fan” tip creates the widest area of cleaning with relatively low pressure. This pressure washer tip is best used for light or delicate cleaning applications. It is recommended for light cleaning on wood decks and other soft or delicate surfaces.</li> </ul>
 <p>SOAP</p>	<p><b>Black - Soap nozzle tip</b></p> <ul style="list-style-type: none"> <li>The black soap degree tip, referred to as the low pressure nozzle. This is for use with soap application. Soap is applied under low pressure high volume for optimum performance. Soap cannot be applied under high pressure with this machine.</li> </ul>
	<p><b>Turbo Nozzle Tip</b></p> <ul style="list-style-type: none"> <li>The nozzle rotates in a zero to 15 degree spray pattern in a circular motion to break down tough dirt and grime. The spray pattern can cover area of 4 to 8 inches wide, depending on a distance between the tip and the surface being cleaned.</li> </ul>

## WARNING

NEVER change nozzles without engaging the lock-out on the trigger handle and NEVER point the wand at your face or at others. The quick-connect feature contains small springs that could eject the nozzle with some force. Failure to heed this may cause personal injury.

- Turn off the pressure washer and shut off the water supply. Pull trigger to release water pressure.
- Engage the lock-out on the trigger handle by pushing the trigger lock button to the right.
- Pull back the quick-connect collar.
- Push the nozzle into place in the spray wand.
- Push the collar forward so that the nozzle is secured properly. Check to see that the nozzle is secure.

### **TO DISCONNECT A NOZZLE FROM THE TRIGGER HANDLE ONCE THE CLEANING JOB IS COMPLETE:**

- Turn off the pressure washer and shut off the water supply. Pull trigger to release water pressure.
- Remove the nozzle by placing hand over nozzle then pulling back the quick-connect collar. Place nozzle in the nozzle storage area on the trigger handle.

### **USING THE SPRAY WAND TRIGGER** (See Figure 10.)

For greater control and safety, keep both hands on the trigger handle at all times.

- Pull back and hold the trigger to operate the pressure washer.
- Release the trigger to stop the flow of water through the nozzle.

### **TO ENGAGE THE LOCK-OUT:**

- Push up on the lock-out until it clicks into the slot.

### **TO DISENGAGE THE LOCK-OUT:**

- Push the lock-out down and into its original position. For the most effective cleaning, the spray nozzle should be between 8 in. and 24 in. from the surface to be cleaned. If the spray is too close it can damage the cleaning surface.

# OPERATION

---

## OPERATING THE PRESSURE WASHER (See Figure 11.)

Use only detergents designed for pressure washers. Many detergents may require mixing prior to use. Prepare cleaning solution as instructed on the solution bottle.

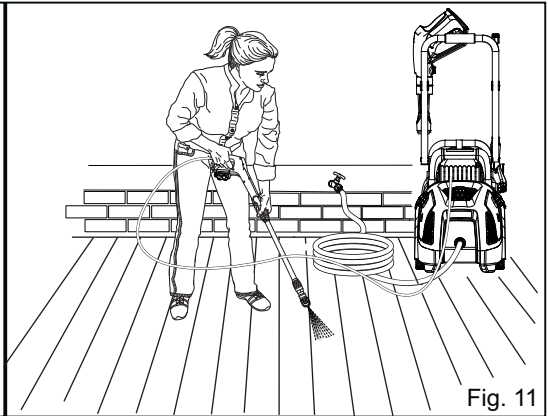
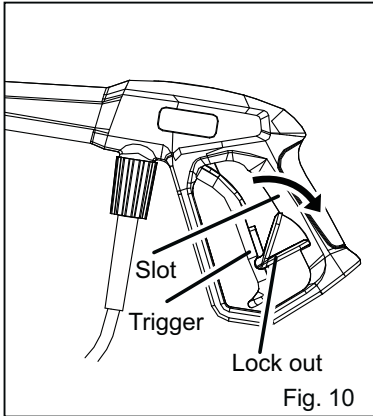

### To clean:

- Pour detergent in the detergent tank.
- Install the black soap nozzle on the spray wand.
- Start the pressure washer and spray the detergent on a dry surface using long, even, overlapping strokes. To prevent streaking, do not allow detergent to dry on the surface.

### To rinse:

- Using the 25° nozzle, spray away from the rinsing surface for approximately 10 seconds to allow any remaining detergent to be flushed from the line.
- Start at the top of the area to be rinsed and work down, overlapping the strokes.

## MOVING THE PRESSURE WASHER

### To move the pressure washer:

- Turn the pressure washer off. Point nozzle in a safe direction and pull trigger to release water pressure.
- Disconnect the high pressure hose from the trigger handle.
- Tilt the machine toward you until it balances on the wheels then roll the machine to the desired position.

# MAINTENANCE

---

---

## **W A R N I N G**

When servicing, use only identical replacement parts. Use of any other parts may create a hazard or cause product damage.

---

---

## **W A R N I N G**

Always wear eye protection with side shields marked to comply with ANSI Z87.1. Failure to do so could result in objects being thrown into your eyes, resulting in possible serious injury.

---

---

## **W A R N I N G**

Before inspecting, cleaning or servicing the machine, shut off engine, wait for all moving parts to stop, disconnect unit from power supply, and pull trigger to release water pressure. Failure to follow these instructions can result in serious personal injury or property damage.

---

## **GENERAL MAINTENANCE**

Avoid using solvents when cleaning plastic parts. Most plastics are susceptible to damage from various types of commercial solvents and may be damaged by their use. Use clean cloths to remove dirt, dust, oil, grease, etc.

---

---

## **W A R N I N G**

Do not at any time let brake fluids, gasoline, petroleum-based products, penetrating oils, etc., come in contact with plastic parts. Chemicals can damage, weaken or destroy plastic which may result in serious personal injury..

---

Only the parts shown on the parts list are intended to be repaired or replaced by the customer. All other parts should be replaced at an authorized service center.

# MAINTENANCE

---

## **NOZZLE MAINTENANCE** (See Figure 12.)

Excessive pump pressure (a pulsing sensation felt while squeezing the trigger) may be the result of a clogged or dirty nozzle.

- Unplug the pressure washer.
- Turn off the pressure washer and shut off the water supply. Pull trigger to release water pressure.
- **Remove the nozzle from the spray wand.**

*NOTE: Never point the spray wand at your face*

Using a straightened paper clip or nozzle cleaning tool (not provided), free any foreign materials clogging or restricting the nozzle.

- Using a garden hose, flush debris out of nozzle by back flushing (running the water through the nozzle backwards or from the outside to the inside).
- Reconnect the nozzle to the spray wand.
- Turn on the water supply.

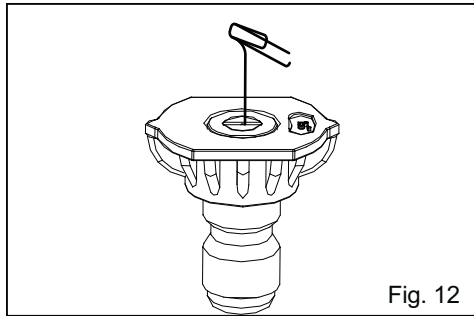

Fig. 12

## **STORING THE PRESSURE WASHER**

Store in a dry, covered area where the weather can't damage it.

It is important to store this product in a frost-free area. Always empty water from all hoses, the pump, and the detergent container before storing.

*NOTE: Use of a pump saver will give you better performance and increase the life of the machine.*

## **QUICK WINTERIZING PROCEDURE**

If you cannot do the Optimum Winterizing procedure, you can still protect your pressure washer from winter-damage by following the steps below:

- Disconnect all water connections.
- Turn on the machine for a few second, until the remaining water in the pump exits. Turn off immediately.
- Do not allow high-pressure hose to become kinked.
- Store the machine and accessories in a room that does not reach freezing temperatures. Do not store near furnace or other sources of heat as it may dry out the pump seals.

---

## **C A U T I O N :**

Drain gun assembly of any remaining water. Aim gun downwards and squeeze trigger.

---

---

# MAINTENANCE

---

## SHUTTING DOWN AND CLEANING UP

- (if you are not using detergent, go directly to Step 2.) When you have finished using the detergent injection system, fill detergent bottle with clean water. Siphon water at low-pressure for one minute so that all detergent is flushed through system. Remove detergent bottle and rinse it thoroughly.
  - Disconnect the garden hose from the water inlet on the unit.
  - Press trigger to release any remaining water pressure.
  - Turn the switch to "OFF" (O) position.
  - Unplug the power cord from the outlet.
  - Engage gun safety lock.
- 

## **W A R N I N G**

Turn off water supply and squeeze trigger to depressurize the unit. Failure to do so could result in personal injury due to discharge of high-pressure water.

---

## **TAKING A BREAK**

If taking a break of five minutes or more.

- Engage gun safety lock.
  - Turn unit to "OFF" (O) position.
  - Unplug the power cord from the outlet.
- 

## **C A U T I O N :**

The use of a pump protector is recommended to prevent cold weather damage during storage over the winter months.

---

# TROUBLESHOOTING

---

<b>PROBLEM</b>	<b>POSSIBLE CAUSE</b>	<b>SOLUTION</b>
Motor will not start.	On/Off switch is in the "OFF" (O) position.	Turn switch to the "ON" ( ) position.
	Power cord is not plugged in.	Plug in power cord.
	Electrical outlet does not supply adequate power.	Try a different outlet.
	Tripped pressure washer circuit breaker	Allow to cool, and restart unit.
	Power switch is ON however gun trigger is not squeezed ON.	With power switch ON push in on the gun trigger which will engage the AUTO ON switch
Unit does not reach high pressure.	Diameter of garden hose is too small.	Replace with a 1" (25 mm) or 5/8" (16 mm) garden hose.
	Water supply is restricted.	Check garden hose for kinks, leaks and blockage.
	Not enough water supply.	Open water source fully.
	Water inlet filter is clogged.	Remove filter and rinse in warm water.
	Power nozzle is in low-pressure position.	Turn power nozzle to high-pressure position.
Output pressure varies high and low.	Not enough inlet water supply.	Turn water on fully. Check garden hose for kinks, leaks or blockage
	Pump is sucking air.	Check that hoses and fittings are airtight. Turn "OFF" machine, and purge pump by squeezing trigger gun until a steady flow of water emerges through the nozzle.
	Water inlet filter is clogged.	Remove filter and rinse with warm water.



# TROUBLESHOOTING

<b>PROBLEM</b>	<b>POSSIBLE CAUSE</b>	<b>SOLUTION</b>
Output pressure varies high and low. (continued)	Discharge nozzle is obstructed.	Blow out or remove debris with a fine needle.
	Calcified gun, hose or power nozzle.	Run distilled vinegar through detergent tank.
Detergent is not coming out.	Is detergent tank selector on and the correct tank selected?	Select the correct tank, either A or B.
	Detergent bottle or suction tube not properly connected.	Check connections.
	Detergent is too thick.	Dilute detergent.
	Filter on detergent suction tube is clogged.	Run warm water through filter to remove build-up.
	Damaged or clogged detergent suction tube.	Remove obstruction or replace detergent suction tube.
	Nozzle is in high-pressure position.	Turn nozzle tip to low-pressure position.
	Discharge nozzle is obstructed.	Blow out or remove debris with a fine needle.
Garden hose connection leaks.	Loose fittings.	Tighten fittings.
	Missing/worn rubber washer.	Insert new washer.
Spray wand, extension, or nozzle leaks.	Broken o-ring or plastic insert.	Call the Toll-Free Hotline.
Pump is noisy	Pump is sucking air	Check that hoses and fittings are airtight. Turn off machine and purge pump by squeezing trigger gun until a steady flow of water emerges through the nozzle.
	Water filter is clogged.	Remove water filter and rinse in warm water.
Water leaks from pump (up to 10 drops per minute is permissible).	Loose fittings.	Check that all fittings are tight.
	Water seals are damaged or worn.	Call the Toll-Free Hotline
Oil is dripping	Oil seals are damaged or worn.	Call the Toll-Free Hotline

# TROUBLESHOOTING

---

<u>PROBLEM</u>	<u>POSSIBLE CAUSE</u>	<u>SOLUTION</u>
Motor buzzes but fails to run.	Supply voltage below minimum.	Verify that only the pressure washer is running on this circuit.
	System has residual pressure.	Turn unit "OFF", squeeze trigger on spray wand to release pressure, then turn unit "ON"
	Voltage loss due to extension cord.	Unplug any extension cords attached and plug the unit directly into the outlet.
	Pressure washer not used for long periods.	Call the Toll-Free Hotline.
	Residual friction among components. Unit might hum.	Disconnect water supply and power ON for 2 to 3 seconds, repeat couple times or until the motor starts.
No Water	Quick connect assembly is attached in reverse.	Verify that Inlet adapter (G2) is attached to machine's water inlet and that the quick connect coupler (G1) is attached to garden hose.
	Water supply is OFF.	Turn ON water supply.
	Kink in the garden hose.	Remove kink in garden hose.

---

**NOTE: AUTO ON/OFF SWITCH: This Pressure washer is equipped with an Auto Start/Stop feature. To operate: Press power switch On (I). Pump will pressurize and shut down immediately. Once the trigger of the gun is depressed the unit will turn on. Unit will shut off and be in standby mode when trigger is released.**

# WARRANTY

---



GREENWORKS  hereby warrants this product, to the original purchaser with **proof of purchase**, for a period of one (1) years against defects in materials, parts or workmanship. GREENWORKS™, at its own discretion will repair or replace any and all parts found to be defective, through normal use, free of charge to the customer. This warranty is valid only for units which have been used for personal use that have not been hired or rented for industrial/commercial use, and that have been maintained in accordance with the instructions in the owners' manual supplied with the product from new.

## ITEMS NOT COVERED BY WARRANTY:

1. Any part that has become inoperative due to misuse, commercial use, abuse, neglect, accident, improper maintenance, or alteration; or
2. The unit, if it has not been operated and/or maintained in accordance with the owner's manual; or
3. Normal wear, except as noted below;
4. Routine maintenance items such as draining the water to avoid freezing/ice damage to pump and components.
5. Normal deterioration of the exterior finish due to use or exposure.

## GREENWORKS HELPLINE (1-888-90WORKS):

Warranty service is available by calling our toll-free helpline, 9am to 5pm EST.  
at **1-888-909-6757 (1-888-90WORKS)**.

## TRANSPORTATION CHARGES:

Transportation charges for the movement of any power equipment unit or attachment are the responsibility of the purchaser. It is the purchaser's responsibility to pay transportation charges for any part submitted for replacement under this warranty unless such return is requested in writing by GREENWORKS.

# EXPLODED VIEW

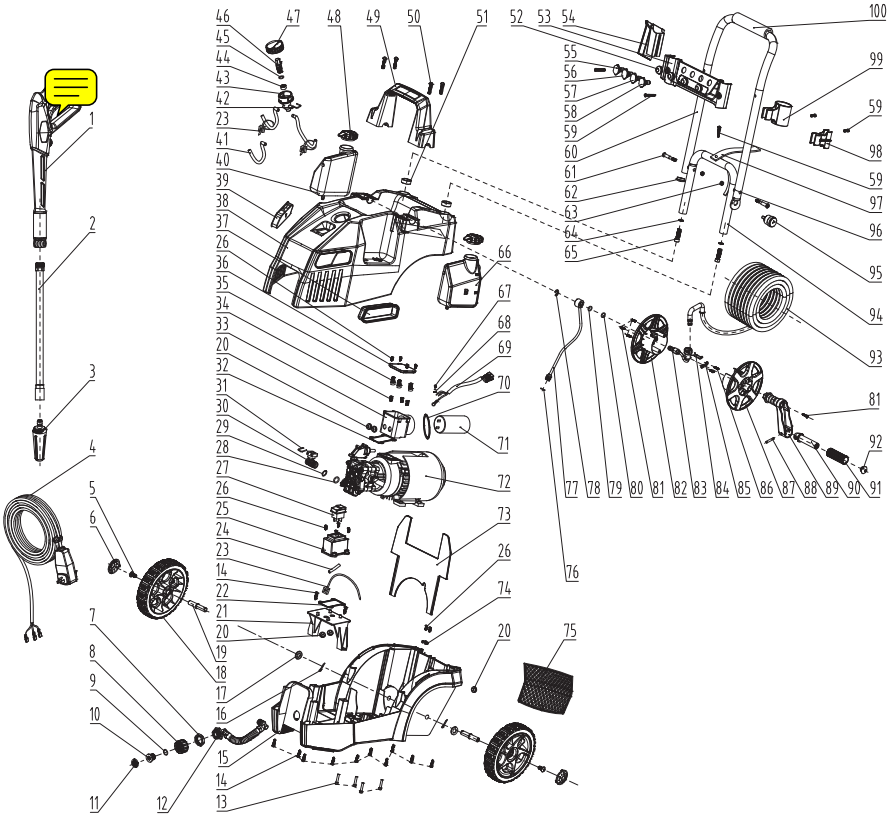

# PARTS LIST

ITEM NO.	PART NO.	DESCRIPTION	QTY
1	31222	Gun handle assembly	1
2	202365	Wand assembly	1
3	31201301A	Turbo nozzle	1
4	31114363	Powercord assembly	1
5	34900363	Screw M8*16	2
6	34135671	Wheel cover	2
7	33210365	Lock nut	1
8	33127302A	Water inlet nut	1
9	34124319	O ring	1
10	34213301A	Water inlet connector	1
11	34132368	Water inlet filter	1
12	31901301A	Water inlet hose assembly	1
13	32203319	Bolt	4
14	32201363	Screw	12
15	34101363	Lower deck	1
16	32907301A	Pin	2
17	32308316A	Washer	2
18	31901363	7in wheel	2
19	33202661	Wheel shaft	2
20	34210301	Rubber cap 1	5
21	34109363	Switch box support	1
22	34206363	Switch box seal	1
23	3411275	Nylon strap	3
24	3030175	Heat-shrinkable tubing $\Phi$ 6	5cm
25	34110363	Switch box	1
26	32211316A	Screw	10
27	36302301A	Power switch	1
28	34212363	O ring	1
29	34211365	Ring	1
30	33101365	Water outlet connector	1
31	33302365	U pin	3
32	34226316A	Motor seal	1
33	34101316A	Capacitance junction box	1
34	32202316A	Screw	3
35	36511154	Wire nut	3
36	34118316A	Junction box	1
37	34104363	Right panel	1
38	34102363	Upper deck	1
39	34103363	Left panel	1
40	34107363	Left soap tank	1
41	34900365	Suction hose	86
42	33302363	Suction U pin	1

# PARTS LIST

ITEM NO.	PART NO.	DESCRIPTION	QTY
43	34117363	Suction rotor cover	1
44	34204363	Suction seal	1
45	34207363	O ring	2
46	34118363	Suction rotor	1
47	34116363	Suction knob	1
48	34216363	Soap tank cover	2
49	34108363	Handle	1
50	3220335	Screw	4
51	34113365	Ring	2
52	34203363	Nozzle rubber cover	4
53	34111363	Panel	1
54	34112363	Gun hook	1
55	31201363	0 degree nozzle	1
56	34139319	Soap nozzle	1
57	31205363	25 degree nozzle	1
58	31203363	40 degree nozzle	1
59	32201319	Screw	3
60	33202363	Upper pull rod	1
61	33204365	Pull rod shaft	2
62	34115363	Pull rod head	1
63	32222301A	M6 Lock nut	2
64	32901363	Washer	2
65	32202363	Bolt	2
66	34106363	Right soap tank	1
67	32204301A	Screw	1
68	32912301A	Washer	1
69	31130363	Wire assembly	1
70	34201316A	O ring	1
71	36488301	Capacitance	1
72	31100363A	Motor and pump assembly	1
73	34105363	Isolation board	1
74	34119316A	Power cord clamp	1
75	34901363	Net bag	1
76	34205131	O ring	1
77	31107661	High pressure hose assembly 1	1
78	32201661	Ring	1
79	34254301	O ring	1
80	34238302A	O ring	1
81	32205316A	Screw	4
82	34102671	Left reel panel	1
83	31108661	High pressure hose assembly 2	1
84	33397363	Pin	1

# PARTS LIST

---

ITEM NO.	PART NO.	DESCRIPTION	QTY
85	34104661	Clamp	1
86	32212316A	Screw	4
87	34121363	Right reel panel	1
88	33203363	Reel pin	1
89	34123363	Reel shaft	1
90	34124363	Reel rotor	1
91	34126363	Reel handle	1
92	34127363	Reel nut	1
93	31121363	High pressure hose assembly	1
94	33303365	Lower rod	1
95	31102661	Lock pin assembly	1
96	33305365	Washer	2
97	34905365	Power cord strap	1
98	34120365	Wand hook	1
99	34121365	Gun handle hook	1
100	34202363	Rod sponge	1

**power**  **works**<sup>TM</sup>

**TOLL-FREE HELPLINE: 1-888-90WORKS** (888.909.6757)

Rev: 04 (05-10-11)

 Printed in China on 100% Recycled Paper